



Providing sustainable energy solutions worldwide



## Bentone B1, B2

Reservdelar och tillbehör  
Spare parts and accessories  
Ersatzteile und Zubehör  
Pièces détachées et accessoires

Gäller från:  
Valid from:  
Gültig ab:  
Valide du:

## Classic

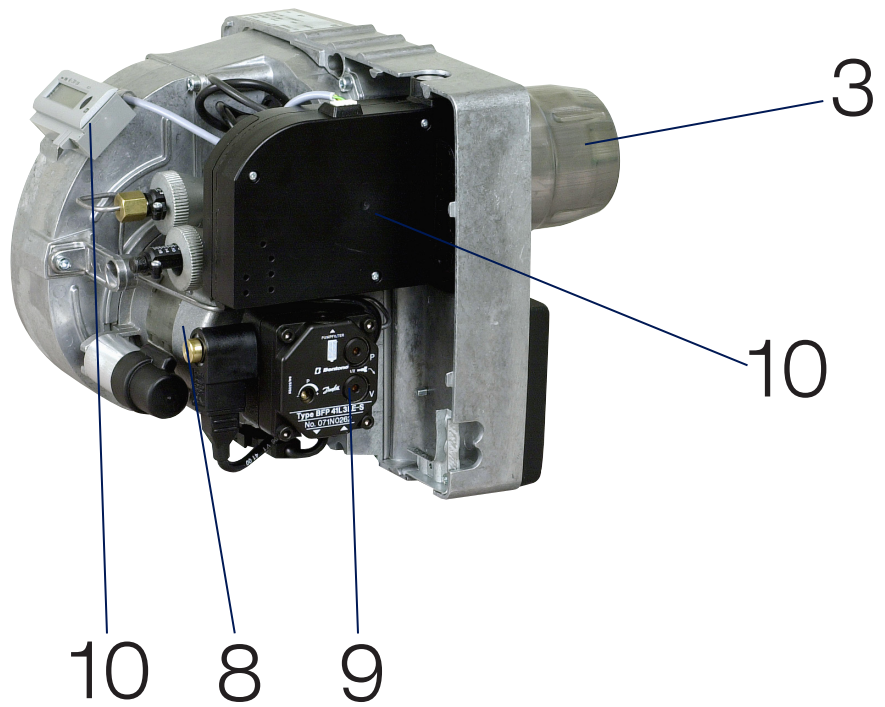
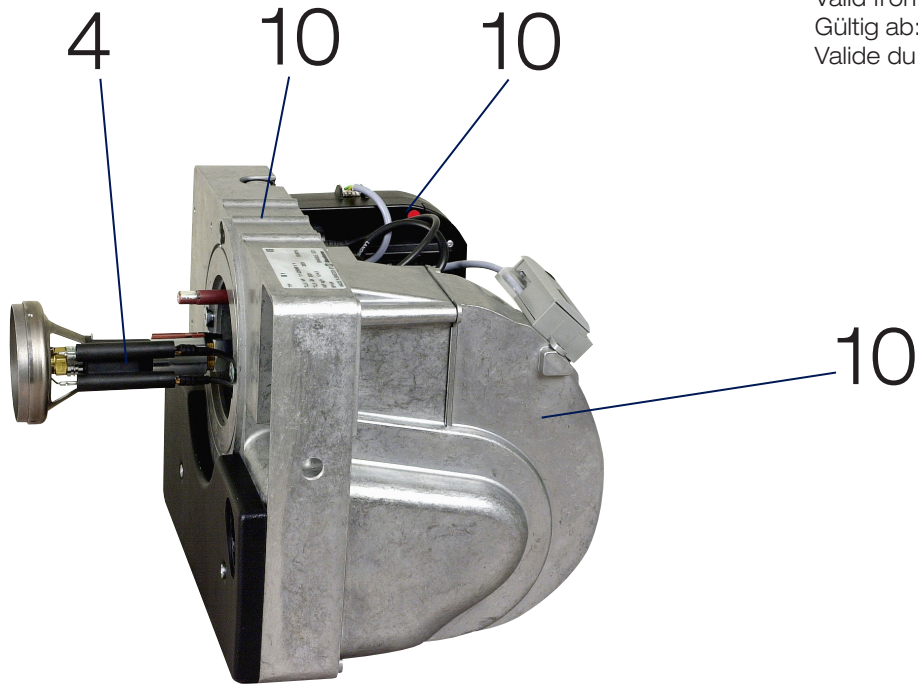











1. Brännarrör • Blast tube • Brennerrohr • Tube diffuseur _____	3
2. Insats • Nozzle Assembly • Düsenstock • Ligne Porte-Gicleur _____	4
3. Anslutningsfläns • Fixing flange • Anschlussflansch • Bridge de fixation _____	6
4. Kåpa • Kåpa • Kåpa • Kåpa _____	7
5. Motor • Motor • Motor • Moteur _____	8
6. Pump • Pump • Pumpe • Pompe _____	9
7. El komponenter • Electric components • El komponenten • Composants électriques _____	10
8. Luftreglering • Air regulation • Luftregelung • Régularisation à air _____	11
9. Fläkthus • Fan housing • Brennergehäuse • Carter du rotor _____	12
10. Oljeslang • Flexible pipe • Ölschlauch • Flexible _____	13

# 1. Brännarrör • Blast tube • Brennerrohr • Tube diffuseur

	Brännarrör	Blast tube	Brennerrohr	Tube diffuseur	
	<b>Prio Miljö, B1RL</b> Ø64 131 mm Ø64 181 mm				11951902 11951903
	<b>Prio, B1RV</b> Ø69 131 mm Ø69 181 mm				11951905 11951906
	Luftfördelare Prio, Prio Miljö	Air distributor	Luftverteiler	Repartiteur d'air	12020401
	Brännarrör FU	Blast tube FU	Brennerrohr FU	Tube diffuseur FU	
	<b>B1 FUV</b> 103 mm 133 mm <b>183 mm</b>				11764301 11764304 <b>11764306</b>
	Brännarrör	Blast tube	Brennerrohr	Tube diffuseur	
	<b>B2SL</b> Ø70 138 mm Ø70 188 mm				11952502 11952503
	<b>B2S, B2SV</b> Ø75 138 mm Ø75 188 mm				11952505 11952506
	Brännarrör	Blast tube	Brennerrohr	Tube diffuseur	
	<b>B2KSV, B2KS,            B2KSV LE</b> Ø76 224 mm Ø76 197 mm				11728411 11728412
	rostfritt Ø76 147mm				11728409
	Ombyggnadsatts	Conversion set	Umbausatz	Jeu de reconstruction	11900610
	<b>PRIO - FUV</b>				



## 2. Insats • Nozzle Assembly • Düsenstock • Ligne Porte-Gicleur

	Insats standard för brännarrör	Nozzle assembly standard design for burner tube	Düsenstock, standard für Brennerrohr	Ligne porte- gicleurstandard pour tube diffuseur	
	<b>B1RV</b> 131 mm 181 mm				11975541 11975542
	<b>B2SV</b> 138 mm 188 mm				11975543 11975544
	<b>B2KSV</b> 147 mm 197 mm				11975545 11975546
	<b>B1 FUV</b> 133 mm				11975555
	Insats, kallstart för brännarrör	Nozzle assembly, cold start for burner tube	Düsenstock, Kallstart für Brennerrohr	Ligne porte-gicleur, demurrage à froid pour tube diffuseur	
	<b>B2S</b> 138 mm 188 mm				11975521 11975522
	<b>B2KS</b> 147 mm 197 mm				11975524 11975525
	<b>B1R</b> 131 mm 181 mm				11975527 11975528
	<b>B1 FU</b> 133 mm				11975556
	Oljerör för brännarrör standard	Nozzle line for burner tube standard	Düsenrohr für Brennerrohr standard	Canne porte-gicleur pour tube diffuseur standard	
	131 - 147 mm 181 - 197 mm				11952201 11952202
	Oljerör för brännarrör Kallstart	Nozzle line for burner tube For cold start	Düsenrohr für Brennerrohr Für Kallstart	Canne porte-gicleur pour tube diffuseur Pour réchauffage	
	131 - 147 mm 181 - 197 mm				12021504 12021505





	Bromsskiva <b>B1, Prio, Prio Miljö</b>	Brake plate	Stauscheibe	Disque accroche- flamme	91975601
	Bromsskiva <b>B2KS</b>	Brake plate	Stauscheibe	Disque accroche- flamme	92026001
	Bromsskiva <b>B2SL B2S, SV</b>	Brake plate	Stauscheibe	Disque accroche- flamme	91984202 91984203
	Bromsskiva <b>B1FU/FUV</b>	Brake plate	Stauscheibe	Disque accroche- flamme	11591501
	Skruv, elektrodhållare <b>B1FU/FUV</b>	Screw, electrode holder	Schraube, Elektrodenhalter	Vis, porte-électrode	12022901
	Tändelektrod <b>B1FU/FUV B2KS</b>	Ignition electrode	Zündelektrode	Électrode d'allumage	11593701
	Fövärmare FPHB LE FPHB FPHD FPHD LE	Preheater	Vorwärmer	Réchauffeur	12086715 12086705 #11470608 #11470609
	O-ring, fövärmare	O-ring, preheater	O-ring, Vorwärmer	Joint torique, réchauffeur	11316802
	Skala, insatsinställning	Scale, nozzle assembly adjustment	Skala, Düsenstock- einstellung	Echelle, réglage de ligne porte-gicleur	11734601

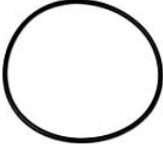









### 3. Anslutningsfläns • Fixing flange • Anschlussflansch • Bridge de fixation

	Kabel, förvärmare	Cable, preheater	Kabel, Vorwärmer	Câble, réchauffeur	11992102
	Ställratt	Adjustment screw	Stellschraube	Vis de reglage	12018301
	Anslutningsfläns	Fixing flange	Anschlussflansch	Bride de fixation	11811601
	Packning	Gasket	Dichtung	Joint	11819101
	Skruv, 8 x 65 upphängning <b>B1</b>	Screw,8X65 suspension	Schraube,8X65 Aufhängung	Vis 8X65, suspension	11412163
	O-ring 84,5 x 3	O-ring	O-ring	Joint torique	11316835

#### 4. Kåpa • Kåpa • Kåpa • Kåpa











	<p>Mellandel kpl. m skruv</p>	<p>Spacing piece compl. with screw</p>	<p>Zwischenteil kompl. mit Schraube</p>	<p>Pièce intermédiaire bride compl. avec vis</p>	<p>11851503</p>
	<p>För montering på CTC1200 Skruv 8X90</p>	<p>To be mounted on CTC1200 Screw 8X90</p>	<p>Für Montage am CTC1200 Schraube 8X90</p>	<p>Pour montage sur CTC1200 Vis 8X90</p>	<p>11412170</p>
	<p><b>B1</b></p>				
	<p>Pinnskruv med mutter</p>	<p>Stud bolt with nut</p>	<p>Stiftschraube mit Mutter</p>	<p>Prisonnier avec écrou</p>	<p>91951702</p>
	<p><b>B2</b></p>				
	<p>Kåpa Röd</p>	<p>Cover Red</p>	<p>Haube Rot</p>	<p>Capot Rouge</p>	<p>11953830</p>
	<p><b>B1</b></p>				
	<p>Kåpa Röd</p>	<p>Cover Red</p>	<p>Haube Rot</p>	<p>Capot Rouge</p>	<p>11971130</p>
	<p><b>B2</b></p>				

## 5. Motor • Motor • Motor • Moteur

	Fäste <b>B1</b> <b>B2</b>	Holder	Halter	Support	11789701 11789702
	Skruv	Screw	Schraube	Vis	11790001
	Motor,110 W 230V, 50/60Hz <b>B1</b> med kabel	Motor	Motor	Moteur	12090601 92090601
	Motor 110 W 230V, 50/60Hz <b>B2</b> med kabel	Motor	Motor	Moteur	12090901 92090901
	Fläkthjul <b>B1</b> TLR 120 x 52 L-E <b>B2</b> TLR 133 x 52 x 8	Fan wheel	Gebälserad	Rotor	11955701 117 27601
	Drivkoppling	Coupling	Kupplung	Accouplement	11756802
	Motorkabel	Motor cable	Motorkabel	Câble, moteur	12086601
	Kondensator 6,3uF	Capacitor	Kondensator	Condensateur	12093701
	Kondensator 4uF ACC	Capacitor	Kondensator	Condensateur	12093001







## 6. Pump • Pump • Pumpe • Pompe

	Pump BFP41L3	Pump	Pumpe	Pompe	12074001
	Med kabel	With cable	Mit Kabel	Avec câble	92074001
	2-rörs	2-pipe	2-Rohr	2 tuyaux	
	Pump BFP41L3LE-S	Pump	Pumpe	Pompe	12074017
	Med kabel	With cable	Mit Kabel	Avec câble	92074017
	2-rörs	2-pipe	2-Rohr	2 tuyaux	
	Förbindelserör	Connecting pipe	Öldruckrohr	Trompette	12007601
	Kabel, pump BFP41L3 BFP41L3LE-S	Cable, pump	Kabel, Pumpe	Câble, pompe	11597507 11992202
	Magnetventil BFP 41	Solenoid valve	Magnetventil	Électrovanne	11597303
	Spole, magnetventil BFP	Coil, solenoid valve	Spule, Magnetventil	Bobine, électrovanne	11597403
	Innerdel, BFP41L3 BFP41L3LE-S	Inner part	Einsatz	Partie intérieure	11774201 11774204
	Filterpatron BFP	Filter	Filter	Filtre	11774901
	Plugg BFP	Plug	Stöpsel	Cheville	11882201
	Packing, lock BFP	Gasket, cover	Dichtung, Deckel	Joint, couvercle	119 81001



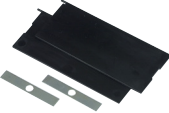

## 7. El komponenter • Electric components • El komponenten • Composants électriques

	Reläbox	Control box	Steuergerät	Boite de contrôle	
	LOA24 Styckförpackning	Single-piece package	Stückverpackung	Emallage par pièces	11559504 91559504
	LMO14 Styckförpackning	Single-piece package	Stückverpackung	Emallage par pièces	12000102 92000102
	Reläsockel	Base, control box	Unterteil, Steuergerät	Socle de raccordement	
	AGK 11 AGK 65				11559600 11559690
	Fotomotstånd QRB1B	Photoresistor	Fotowiderstand	Cellule photorésistante,	11992402
	Kontakt don hona 7-polig utan kåpa	Plug-in contact, female 7-pole without cover	Buchsenteil 7-polig ohne haube	Prise "européenne" femelle 7-polaire sans capot	11558606
	Kåpa	Cover	Haube	Capot	11558502
	Kontakt don 7-pol hane	Plug-in contact, male 7-pole	Steckerteil 7-polig	Prise "européenne" mâle 7-polaire	11558500
	Transformator EBI	Transformer EBI	Transformator EBI	Transformateur EBI	12064301
	Med kabel	With cable	Mit Kabel	Avec Câble	92064301
	Kabel, transformator 400 mm	Cable, transformer 400 mm	Kabel, Transformator 400 mm	Câble, transformateur 400 mm	12062002
	Tändkabelpar 430 mm	Pair of ignition cable	Zündkabelpar	Câble d'allumage, paire	12068145



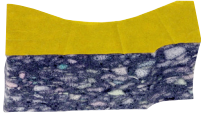

## 8. Luftreglering • Air regulation • Luftregelung • Régularisation à air

	Självstängande luftspjäll kpl. <b>B1</b>	Automatic air damper	Luftansaugvorrichtung	Clapet d'air automatique	12018201
	Självstängande luftspjäll kpl. <b>B2</b>	Automatic air damper	Luftansaugvorrichtung	Clapet d'air automatique	12018202
	Luftspjäll <b>B1</b>	Air damper	Luftklappe	Volet d'air	11977401
	Ställratt <b>B1</b>	Adjustment screw	Stellschraube	Vis de réglage	12018301
	Skala, luftinställning <b>B1</b>	Scale, air adjustment	Skala, Lufteinstellung	Echelle, réglage d'air	11734602
	Luftreglering <b>B2</b>	Air adjustment	Lufteinstellung	Réglage d'air	11901603

9. Fläkthus • Fan housing • Brennergehäuse • Carter du rotor

	<p>Insugningsplatta</p> <p><b>B1</b></p>	Suction plate	Ansaugplatte	Disque d'aspiration	11976101
	<p>Isolering</p> <p><b>B1</b></p>	Insulation	Isolierung	Isolation	12015101
	<p>Isolering</p> <p><b>B1</b></p>	Insulation	Isolierung	Isolation	12015201
	<p>Isolering</p> <p><b>B1</b></p>	Insulation	Isolierung	Isolation	12015301
	<p>Plåt, ljuddämpare</p> <p><b>B1</b></p>	Plate, silencer	Blech, Schalldämpfer	Tôle de silencieux	12015601
	<p>Oljeslang</p> <p>1/4 700 mm 1/4 1000 mm 3/8 1000 mm</p>	Flexible pipe	Ölschlauch	Flexible	11946501 11946502 11946503

## 10. Oljeslang • Flexible pipe • Ölschlauch • Flexible

	Hållare, oljeslang	Bracket	Klammer	Crampon	11912201
	Nippel 1/4"x1/4"	Nipple	Nippel	Raccord	11757401
	Oljefilter, Bentone	Oil filter Bentone	Ölfiter Bentone	Filtre d'huile Bentone	11932301
	Filterinsats Bentone	Filter Bentone	Filter Bentone	Filtre Bentone	11887701







